

Power contactor, AC-3 115 A, 55 kW / 400 V AC (50-60 Hz) / DC operation 42-48 V UC Auxiliary contacts 2 NO + 2 NC 3-pole, Size S6 Busbar connections Drive: conventional screw terminal



Figure similar

Product brand name	SIRIUS
Product designation	Power contactor
Product type designation	3RT1
General technical data	
Size of contactor	S6
Product extension	
• function module for communication	No
• Auxiliary switch	Yes
Surge voltage resistance	
• of main circuit rated value	8 kV
• of auxiliary circuit rated value	6 kV
maximum permissible voltage for safe isolation	
• between coil and main contacts acc. to EN 60947-1	690 V
Protection class IP	
• on the front	IP00; IP20 on the front with cover / box terminal
• of the terminal	IP00

Shock resistance at rectangular impulse	
<ul style="list-style-type: none"> • at AC • at DC 	8,5g / 5 ms, 4,2g / 10 ms 8,5g / 5 ms, 4,2g / 10 ms
Shock resistance with sine pulse	
<ul style="list-style-type: none"> • at AC • at DC 	13,4g / 5 ms, 6,5g / 10 ms 13,4g / 5 ms, 6,5g / 10 ms
Mechanical service life (switching cycles)	
<ul style="list-style-type: none"> • of contactor typical • of the contactor with added electronics-compatible auxiliary switch block typical • of the contactor with added auxiliary switch block typical 	10 000 000 5 000 000 10 000 000
Reference code acc. to DIN 40719 extended according to IEC 204-2 acc. to IEC 750	K
Reference code acc. to DIN EN 81346-2	Q

Ambient conditions

Installation altitude at height above sea level	
<ul style="list-style-type: none"> • maximum 	2 000 m
Ambient temperature	
<ul style="list-style-type: none"> • during operation • during storage 	-25 ... +60 °C -55 ... +80 °C

Main circuit

Number of poles for main current circuit	3
Number of NO contacts for main contacts	3
Operating voltage	
<ul style="list-style-type: none"> • at AC-3 rated value maximum 	1 000 V
Operating current	
<ul style="list-style-type: none"> • at AC-1 at 400 V <ul style="list-style-type: none"> — at ambient temperature 40 °C rated value • at AC-1 <ul style="list-style-type: none"> — up to 690 V at ambient temperature 40 °C rated value — up to 690 V at ambient temperature 60 °C rated value — up to 1000 V at ambient temperature 40 °C rated value — up to 1000 V at ambient temperature 60 °C rated value • at AC-2 at 400 V rated value • at AC-3 <ul style="list-style-type: none"> — at 400 V rated value — at 500 V rated value 	160 A 160 A 140 A 80 A 80 A 115 A 115 A 115 A

— at 690 V rated value	115 A
— at 1000 V rated value	53 A
• at AC-4 at 400 V rated value	97 A
Connectable conductor cross-section in main circuit at AC-1	
• at 60 °C minimum permissible	50 mm ²
• at 40 °C minimum permissible	70 mm ²
Operating current for approx. 200000 operating cycles at AC-4	
• at 400 V rated value	54 A
• at 690 V rated value	48 A
Operating current	
• at 1 current path at DC-1	
— at 24 V rated value	160 A
— at 110 V rated value	18 A
— at 220 V rated value	3.4 A
— at 440 V rated value	0.8 A
— at 600 V rated value	0.5 A
• with 2 current paths in series at DC-1	
— at 24 V rated value	160 A
— at 110 V rated value	160 A
— at 220 V rated value	20 A
— at 440 V rated value	3.2 A
— at 600 V rated value	1.6 A
• with 3 current paths in series at DC-1	
— at 24 V rated value	160 A
— at 110 V rated value	160 A
— at 220 V rated value	160 A
— at 440 V rated value	11.5 A
— at 600 V rated value	4 A
Operating current	
• at 1 current path at DC-3 at DC-5	
— at 24 V rated value	160 A
— at 110 V rated value	2.5 A
— at 220 V rated value	0.6 A
— at 440 V rated value	0.17 A
— at 600 V rated value	0.12 A
• with 2 current paths in series at DC-3 at DC-5	
— at 24 V rated value	160 A
— at 110 V rated value	160 A
— at 220 V rated value	2.5 A
— at 440 V rated value	0.65 A

<ul style="list-style-type: none"> — at 600 V rated value 	0.37 A
<ul style="list-style-type: none"> • with 3 current paths in series at DC-3 at DC-5 <ul style="list-style-type: none"> — at 24 V rated value — at 110 V rated value — at 220 V rated value — at 440 V rated value — at 600 V rated value 	160 A 160 A 160 A 1.4 A 0.75 A
Operating power	
<ul style="list-style-type: none"> • at AC-1 <ul style="list-style-type: none"> — at 230 V at 60 °C rated value — at 400 V rated value — at 400 V at 60 °C rated value — at 690 V rated value — at 690 V at 60 °C rated value — at 1000 V at 60 °C rated value • at AC-2 at 400 V rated value • at AC-3 <ul style="list-style-type: none"> — at 230 V rated value — at 400 V rated value — at 500 V rated value — at 690 V rated value — at 1000 V rated value 	53 kW 92 kW 92 kW 159 kW 159 kW 131 kW 55 kW 37 kW 55 kW 75 kW 110 kW 75 kW
Operating power for approx. 200000 operating cycles at AC-4	
<ul style="list-style-type: none"> • at 400 V rated value • at 690 V rated value 	29 kW 48 kW
Thermal short-time current limited to 10 s	1 100 A
Power loss [W] at AC-3 at 400 V for rated value of the operating current per conductor	7 W
No-load switching frequency	
<ul style="list-style-type: none"> • at AC • at DC 	2 000 1/h 2 000 1/h
Operating frequency	
<ul style="list-style-type: none"> • at AC-1 maximum • at AC-2 maximum • at AC-3 maximum • at AC-4 maximum 	800 1/h 400 1/h 1 000 1/h 130 1/h
Control circuit/ Control	
Type of voltage of the control supply voltage	AC/DC
Control supply voltage at AC	
<ul style="list-style-type: none"> • at 50 Hz rated value 	42 ... 48 V

<ul style="list-style-type: none"> • at 60 Hz rated value 	42 ... 48 V
Control supply voltage at DC	
<ul style="list-style-type: none"> • rated value 	42 ... 48 V
Operating range factor control supply voltage rated value of magnet coil at DC	
<ul style="list-style-type: none"> • initial value 	0.8
<ul style="list-style-type: none"> • Full-scale value 	1.1
Operating range factor control supply voltage rated value of magnet coil at AC	
<ul style="list-style-type: none"> • at 50 Hz 	0.8 ... 1.1
<ul style="list-style-type: none"> • at 60 Hz 	0.8 ... 1.1
Design of the surge suppressor	with varistor
Apparent pick-up power of magnet coil at AC	
<ul style="list-style-type: none"> • at 50 Hz 	300 V·A
Inductive power factor with closing power of the coil	
<ul style="list-style-type: none"> • at 50 Hz 	0.9
Apparent holding power of magnet coil at AC	
<ul style="list-style-type: none"> • at 50 Hz 	5.8 V·A
Inductive power factor with the holding power of the coil	
<ul style="list-style-type: none"> • at 50 Hz 	0.8
Closing power of magnet coil at DC	360 W
Holding power of magnet coil at DC	5.2 W
Closing delay	
<ul style="list-style-type: none"> • at AC 	20 ... 95 ms
<ul style="list-style-type: none"> • at DC 	20 ... 95 ms
Opening delay	
<ul style="list-style-type: none"> • at AC 	40 ... 60 ms
<ul style="list-style-type: none"> • at DC 	40 ... 60 ms
Arcing time	10 ... 15 ms
Control version of the switch operating mechanism	Standard A1 - A2
Auxiliary circuit	
Number of NC contacts for auxiliary contacts	
<ul style="list-style-type: none"> • instantaneous contact 	2
Number of NO contacts for auxiliary contacts	
<ul style="list-style-type: none"> • instantaneous contact 	2
Operating current at AC-12 maximum	10 A
Operating current at AC-15	
<ul style="list-style-type: none"> • at 230 V rated value 	6 A
<ul style="list-style-type: none"> • at 400 V rated value 	3 A
<ul style="list-style-type: none"> • at 500 V rated value 	2 A
<ul style="list-style-type: none"> • at 690 V rated value 	1 A

Operating current at DC-12	
<ul style="list-style-type: none"> • at 24 V rated value • at 48 V rated value • at 60 V rated value • at 110 V rated value • at 125 V rated value • at 220 V rated value • at 600 V rated value 	<p>10 A</p> <p>6 A</p> <p>6 A</p> <p>3 A</p> <p>2 A</p> <p>1 A</p> <p>0.15 A</p>
Operating current at DC-13	
<ul style="list-style-type: none"> • at 24 V rated value • at 48 V rated value • at 60 V rated value • at 110 V rated value • at 125 V rated value • at 220 V rated value • at 600 V rated value 	<p>10 A</p> <p>2 A</p> <p>2 A</p> <p>1 A</p> <p>0.9 A</p> <p>0.3 A</p> <p>0.1 A</p>
Contact reliability of auxiliary contacts	1 faulty switching per 100 million (17 V, 1 mA)

UL/CSA ratings

Full-load current (FLA) for three-phase AC motor	
<ul style="list-style-type: none"> • at 480 V rated value • at 600 V rated value 	<p>124 A</p> <p>125 A</p>
Yielded mechanical performance [hp]	
<ul style="list-style-type: none"> • for single-phase AC motor <ul style="list-style-type: none"> — at 230 V rated value • for three-phase AC motor <ul style="list-style-type: none"> — at 200/208 V rated value — at 220/230 V rated value — at 460/480 V rated value — at 575/600 V rated value 	<p>25 hp</p> <p>40 hp</p> <p>50 hp</p> <p>100 hp</p> <p>125 hp</p>
Contact rating of auxiliary contacts according to UL	A600 / Q600

Short-circuit protection

Design of the fuse link	
<ul style="list-style-type: none"> • for short-circuit protection of the main circuit <ul style="list-style-type: none"> — with type of coordination 1 required — with type of assignment 2 required • for short-circuit protection of the auxiliary switch required 	<p>gG: 355 A (690 V, 100 kA)</p> <p>gG: 315 A (690 V, 100 kA), aM: 200 A (690 V, 50 kA), BS88: 250 A (415 V, 50 kA)</p> <p>fuse gG: 10 A</p>

Installation/ mounting/ dimensions

Mounting position	with vertical mounting surface +/-90° rotatable, with vertical mounting surface +/- 22.5° tiltable to the front and back
--------------------------	--

Mounting type	screw fixing
• Side-by-side mounting	Yes
Height	172 mm
Width	120 mm
Depth	170 mm
Required spacing	
• with side-by-side mounting	
— forwards	20 mm
— upwards	10 mm
— downwards	10 mm
— at the side	0 mm
• for grounded parts	
— forwards	20 mm
— upwards	10 mm
— at the side	10 mm
— downwards	10 mm
• for live parts	
— forwards	20 mm
— upwards	10 mm
— downwards	10 mm
— at the side	10 mm

Connections/Terminals	
Type of electrical connection	
• for main current circuit	Connection bar
• for auxiliary and control current circuit	screw-type terminals
Type of connectable conductor cross-sections	
• at AWG conductors for main contacts	4 ... 250 kcmil
Connectable conductor cross-section for main contacts	
• stranded	25 ... 120 mm ²
Connectable conductor cross-section for auxiliary contacts	
• single or multi-stranded	0.5 ... 4 mm ²
• finely stranded with core end processing	0.5 ... 2.5 mm ²
Type of connectable conductor cross-sections	
• for auxiliary contacts	
— solid	2x (0.5 ... 1.5 mm ²), 2x (0.75 ... 2.5 mm ²), max. 2x (0.75 ... 4 mm ²)
— single or multi-stranded	2x (0,5 ... 1,5 mm ²), 2x (0,75 ... 2,5 mm ²), max. 2x (0,75 ... 4 mm ²)
— finely stranded with core end processing	2x (0.5 ... 1.5 mm ²), 2x (0.75 ... 2.5 mm ²)
• at AWG conductors for auxiliary contacts	2x (20 ... 16), 2x (18 ... 14), 1x 12
AWG number as coded connectable conductor cross section	

- for auxiliary contacts



18 ... 14

Safety related data

Product function	
<ul style="list-style-type: none"> • Mirror contact acc. to IEC 60947-4-1 • positively driven operation acc. to IEC 60947-5-1 	<p>Yes</p> <p>No</p>
Protection against electrical shock	finger-safe when touched vertically from front acc. to IEC 60529

Certificates/approvals

General Product Approval	Functional Safety/Safety of Machinery	Declaration of Conformity
 CCC  CSA  UL  EAC	Type Examination Certificate	 EG-Konf.

Test Certificates	Marine / Shipping	other
Special Test Certificate Type Test Certificates/Test Report	 ABS  RMRS  DNV-GL <small>DNVGL.COM/AF</small>	Miscellaneous

other
Confirmation

Further information

- Information- and Downloadcenter (Catalogs, Brochures,...)**
<http://www.siemens.com/industrial-controls/catalogs>
- Industry Mall (Online ordering system)**
<https://mall.industry.siemens.com/mall/en/en/Catalog/product?mlfb=3RT1054-6AD36>
- Cax online generator**
<http://support.automation.siemens.com/WW/CAXorder/default.aspx?lang=en&mlfb=3RT1054-6AD36>
- Service&Support (Manuals, Certificates, Characteristics, FAQs,...)**
<https://support.industry.siemens.com/cs/ww/en/ps/3RT1054-6AD36>
- Image database (product images, 2D dimension drawings, 3D models, device circuit diagrams, EPLAN macros, ...)**
http://www.automation.siemens.com/bilddb/cax_de.aspx?mlfb=3RT1054-6AD36&lang=en
- Characteristic: Tripping characteristics, I²t, Let-through current**
<https://support.industry.siemens.com/cs/ww/en/ps/3RT1054-6AD36/char>
- Further characteristics (e.g. electrical endurance, switching frequency)**
<http://www.automation.siemens.com/bilddb/index.aspx?view=Search&mlfb=3RT1054-6AD36&objecttype=14&gridview=view1>

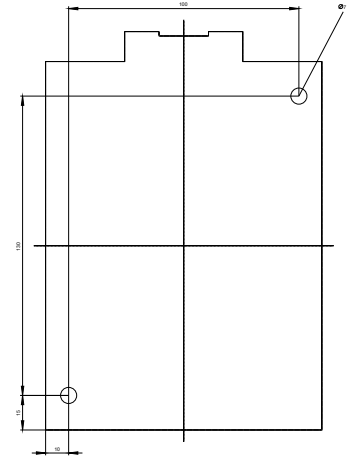
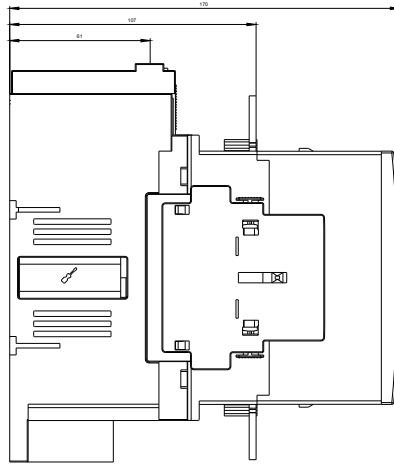
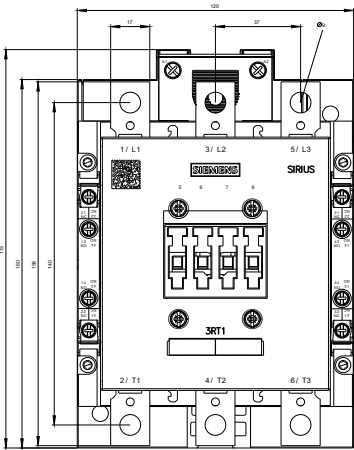



last modified:

12/19/2018