

Power contactor, AC-3 150 A, 75 kW / 400 V AC (50-60 Hz) / DC operation 575-600 V UC Auxiliary contacts 2 NO + 2 NC 3-pole, Size S6 Busbar connections Drive: conventional screw terminal



Figure similar

| | |
|---|---|
| Product brand name | SIRIUS |
| Product designation | Power contactor |
| Product type designation | 3RT1 |
| General technical data | |
| Size of contactor | S6 |
| Product extension | |
| • function module for communication | No |
| • Auxiliary switch | Yes |
| Surge voltage resistance | |
| • of main circuit rated value | 8 kV |
| • of auxiliary circuit rated value | 6 kV |
| maximum permissible voltage for safe isolation | |
| • between coil and main contacts acc. to EN 60947-1 | 690 V |
| Protection class IP | |
| • on the front | IP00; IP20 on the front with cover / box terminal |
| • of the terminal | IP00 |

| | |
|---|--|
| Shock resistance at rectangular impulse | |
| <ul style="list-style-type: none"> • at AC • at DC | 8,5g / 5 ms, 4,2g / 10 ms 8,5g / 5 ms, 4,2g / 10 ms |
| Shock resistance with sine pulse | |
| <ul style="list-style-type: none"> • at AC • at DC | 13,4g / 5 ms, 6,5g / 10 ms 13,4g / 5 ms, 6,5g / 10 ms |
| Mechanical service life (switching cycles) | |
| <ul style="list-style-type: none"> • of contactor typical • of the contactor with added electronics-compatible auxiliary switch block typical • of the contactor with added auxiliary switch block typical | 10 000 000 5 000 000 10 000 000 |
| Reference code acc. to DIN 40719 extended according to IEC 204-2 acc. to IEC 750 | K |
| Reference code acc. to DIN EN 81346-2 | Q |

Ambient conditions

| | |
|--|----------------------------------|
| Installation altitude at height above sea level | |
| <ul style="list-style-type: none"> • maximum | 2 000 m |
| Ambient temperature | |
| <ul style="list-style-type: none"> • during operation • during storage | -25 ... +60 °C -55 ... +80 °C |

Main circuit

| | |
|--|--|
| Number of poles for main current circuit | 3 |
| Number of NO contacts for main contacts | 3 |
| Operating voltage | |
| <ul style="list-style-type: none"> • at AC-3 rated value maximum | 1 000 V |
| Operating current | |
| <ul style="list-style-type: none"> • at AC-1 at 400 V <ul style="list-style-type: none"> — at ambient temperature 40 °C rated value • at AC-1 <ul style="list-style-type: none"> — up to 690 V at ambient temperature 40 °C rated value — up to 690 V at ambient temperature 60 °C rated value — up to 1000 V at ambient temperature 40 °C rated value — up to 1000 V at ambient temperature 60 °C rated value • at AC-2 at 400 V rated value • at AC-3 <ul style="list-style-type: none"> — at 400 V rated value — at 500 V rated value | 185 A 185 A 160 A 90 A 90 A 150 A 150 A 150 A |

| | |
|--|--------------------|
| — at 690 V rated value | 150 A |
| — at 1000 V rated value | 65 A |
| • at AC-4 at 400 V rated value | 132 A |
| Connectable conductor cross-section in main circuit at AC-1 | |
| • at 60 °C minimum permissible | 70 mm ² |
| • at 40 °C minimum permissible | 95 mm ² |
| Operating current for approx. 200000 operating cycles at AC-4 | |
| • at 400 V rated value | 68 A |
| • at 690 V rated value | 57 A |
| Operating current | |
| • at 1 current path at DC-1 | |
| — at 24 V rated value | 160 A |
| — at 110 V rated value | 18 A |
| — at 220 V rated value | 3.4 A |
| — at 440 V rated value | 0.8 A |
| — at 600 V rated value | 0.5 A |
| • with 2 current paths in series at DC-1 | |
| — at 24 V rated value | 160 A |
| — at 110 V rated value | 160 A |
| — at 220 V rated value | 20 A |
| — at 440 V rated value | 3.2 A |
| — at 600 V rated value | 1.6 A |
| • with 3 current paths in series at DC-1 | |
| — at 24 V rated value | 160 A |
| — at 110 V rated value | 160 A |
| — at 220 V rated value | 160 A |
| — at 440 V rated value | 11.5 A |
| — at 600 V rated value | 4 A |
| Operating current | |
| • at 1 current path at DC-3 at DC-5 | |
| — at 24 V rated value | 160 A |
| — at 110 V rated value | 2.5 A |
| — at 220 V rated value | 0.6 A |
| — at 440 V rated value | 0.17 A |
| — at 600 V rated value | 0.12 A |
| • with 2 current paths in series at DC-3 at DC-5 | |
| — at 24 V rated value | 160 A |
| — at 110 V rated value | 160 A |
| — at 220 V rated value | 2.5 A |
| — at 440 V rated value | 0.65 A |

| | |
|--|--|
| <ul style="list-style-type: none"> — at 600 V rated value | 0.37 A |
| <ul style="list-style-type: none"> • with 3 current paths in series at DC-3 at DC-5 <ul style="list-style-type: none"> — at 24 V rated value — at 110 V rated value — at 220 V rated value — at 440 V rated value — at 600 V rated value | 160 A 160 A 160 A 1.4 A 0.75 A |
| Operating power | |
| <ul style="list-style-type: none"> • at AC-1 <ul style="list-style-type: none"> — at 230 V at 60 °C rated value — at 400 V rated value — at 400 V at 60 °C rated value — at 690 V rated value — at 690 V at 60 °C rated value — at 1000 V at 60 °C rated value • at AC-2 at 400 V rated value • at AC-3 <ul style="list-style-type: none"> — at 230 V rated value — at 400 V rated value — at 500 V rated value — at 690 V rated value — at 1000 V rated value | 60 kW 105 kW 105 kW 181 kW 181 kW 148 kW 75 kW 45 kW 75 kW 90 kW 132 kW 90 kW |
| Operating power for approx. 200000 operating cycles at AC-4 | |
| <ul style="list-style-type: none"> • at 400 V rated value • at 690 V rated value | 38 kW 55 kW |
| Thermal short-time current limited to 10 s | 1 300 A |
| Power loss [W] at AC-3 at 400 V for rated value of the operating current per conductor | 9 W |
| No-load switching frequency | |
| <ul style="list-style-type: none"> • at AC • at DC | 2 000 1/h 2 000 1/h |
| Operating frequency | |
| <ul style="list-style-type: none"> • at AC-1 maximum • at AC-2 maximum • at AC-3 maximum • at AC-4 maximum | 800 1/h 300 1/h 750 1/h 130 1/h |
| Control circuit/ Control | |
| Type of voltage of the control supply voltage | AC/DC |
| Control supply voltage at AC | |
| <ul style="list-style-type: none"> • at 50 Hz rated value | 575 ... 600 V |

| | |
|--|------------------------------|
| <ul style="list-style-type: none"> • at 60 Hz rated value | 575 ... 600 V |
| Control supply voltage at DC | |
| <ul style="list-style-type: none"> • rated value | 575 ... 600 V |
| Operating range factor control supply voltage rated value of magnet coil at DC | |
| <ul style="list-style-type: none"> • initial value • Full-scale value | 0.8 1.1 |
| Operating range factor control supply voltage rated value of magnet coil at AC | |
| <ul style="list-style-type: none"> • at 50 Hz • at 60 Hz | 0.8 ... 1.1 0.8 ... 1.1 |
| Design of the surge suppressor | with varistor |
| Apparent pick-up power of magnet coil at AC | |
| <ul style="list-style-type: none"> • at 50 Hz | 300 V·A |
| Inductive power factor with closing power of the coil | |
| <ul style="list-style-type: none"> • at 50 Hz | 0.9 |
| Apparent holding power of magnet coil at AC | |
| <ul style="list-style-type: none"> • at 50 Hz | 5.8 V·A |
| Inductive power factor with the holding power of the coil | |
| <ul style="list-style-type: none"> • at 50 Hz | 0.8 |
| Closing power of magnet coil at DC | 360 W |
| Holding power of magnet coil at DC | 5.2 W |
| Closing delay | |
| <ul style="list-style-type: none"> • at AC • at DC | 20 ... 95 ms 20 ... 95 ms |
| Opening delay | |
| <ul style="list-style-type: none"> • at AC • at DC | 40 ... 60 ms 40 ... 60 ms |
| Arcing time | 10 ... 15 ms |
| Control version of the switch operating mechanism | Standard A1 - A2 |
| Auxiliary circuit | |
| Number of NC contacts for auxiliary contacts | |
| <ul style="list-style-type: none"> • instantaneous contact | 2 |
| Number of NO contacts for auxiliary contacts | |
| <ul style="list-style-type: none"> • instantaneous contact | 2 |
| Operating current at AC-12 maximum | 10 A |
| Operating current at AC-15 | |
| <ul style="list-style-type: none"> • at 230 V rated value • at 400 V rated value • at 500 V rated value • at 690 V rated value | 6 A 3 A 2 A 1 A |

| | |
|---|---|
| Operating current at DC-12 | |
| <ul style="list-style-type: none"> • at 24 V rated value • at 48 V rated value • at 60 V rated value • at 110 V rated value • at 125 V rated value • at 220 V rated value • at 600 V rated value | <p>10 A</p> <p>6 A</p> <p>6 A</p> <p>3 A</p> <p>2 A</p> <p>1 A</p> <p>0.15 A</p> |
| Operating current at DC-13 | |
| <ul style="list-style-type: none"> • at 24 V rated value • at 48 V rated value • at 60 V rated value • at 110 V rated value • at 125 V rated value • at 220 V rated value • at 600 V rated value | <p>10 A</p> <p>2 A</p> <p>2 A</p> <p>1 A</p> <p>0.9 A</p> <p>0.3 A</p> <p>0.1 A</p> |
| Contact reliability of auxiliary contacts | 1 faulty switching per 100 million (17 V, 1 mA) |

UL/CSA ratings

| | |
|---|--|
| Full-load current (FLA) for three-phase AC motor | |
| <ul style="list-style-type: none"> • at 480 V rated value • at 600 V rated value | <p>156 A</p> <p>144 A</p> |
| Yielded mechanical performance [hp] | |
| <ul style="list-style-type: none"> • for single-phase AC motor <ul style="list-style-type: none"> — at 230 V rated value • for three-phase AC motor <ul style="list-style-type: none"> — at 200/208 V rated value — at 220/230 V rated value — at 460/480 V rated value — at 575/600 V rated value | <p>30 hp</p> <p>50 hp</p> <p>60 hp</p> <p>125 hp</p> <p>150 hp</p> |
| Contact rating of auxiliary contacts according to UL | A600 / Q600 |

Short-circuit protection

| | |
|---|--|
| Design of the fuse link | |
| <ul style="list-style-type: none"> • for short-circuit protection of the main circuit <ul style="list-style-type: none"> — with type of coordination 1 required — with type of assignment 2 required • for short-circuit protection of the auxiliary switch required | <p>gG: 355 A (690 V, 100 kA)</p> <p>gG: 315 A (690 V, 100 kA), aM: 200 A (690 V, 50 kA), BS88: 315 A (415 V, 50 kA)</p> <p>fuse gG: 10 A</p> |

Installation/ mounting/ dimensions

| | |
|--------------------------|--|
| Mounting position | with vertical mounting surface +/-90° rotatable, with vertical mounting surface +/- 22.5° tiltable to the front and back |
|--------------------------|--|

| | |
|------------------------------|--------------|
| Mounting type | screw fixing |
| • Side-by-side mounting | Yes |
| Height | 172 mm |
| Width | 120 mm |
| Depth | 170 mm |
| Required spacing | |
| • with side-by-side mounting | |
| — forwards | 20 mm |
| — upwards | 10 mm |
| — downwards | 10 mm |
| — at the side | 0 mm |
| • for grounded parts | |
| — forwards | 20 mm |
| — upwards | 10 mm |
| — at the side | 10 mm |
| — downwards | 10 mm |
| • for live parts | |
| — forwards | 20 mm |
| — upwards | 10 mm |
| — downwards | 10 mm |
| — at the side | 10 mm |

| Connections/Terminals | |
|---|--|
| Type of electrical connection | |
| • for main current circuit | Connection bar |
| • for auxiliary and control current circuit | screw-type terminals |
| Type of connectable conductor cross-sections | |
| • at AWG conductors for main contacts | 4 ... 250 kcmil |
| Connectable conductor cross-section for main contacts | |
| • stranded | 25 ... 120 mm ² |
| Connectable conductor cross-section for auxiliary contacts | |
| • single or multi-stranded | 0.5 ... 4 mm ² |
| • finely stranded with core end processing | 0.5 ... 2.5 mm ² |
| Type of connectable conductor cross-sections | |
| • for auxiliary contacts | |
| — solid | 2x (0.5 ... 1.5 mm ²), 2x (0.75 ... 2.5 mm ²), max. 2x (0.75 ... 4 mm ²) |
| — single or multi-stranded | 2x (0,5 ... 1,5 mm ²), 2x (0,75 ... 2,5 mm ²), max. 2x (0,75 ... 4 mm ²) |
| — finely stranded with core end processing | 2x (0.5 ... 1.5 mm ²), 2x (0.75 ... 2.5 mm ²) |
| • at AWG conductors for auxiliary contacts | 2x (20 ... 16), 2x (18 ... 14), 1x 12 |
| AWG number as coded connectable conductor cross section | |

- for auxiliary contacts



18 ... 14

Safety related data

| | |
|---|--|
| Product function | |
| <ul style="list-style-type: none"> • Mirror contact acc. to IEC 60947-4-1 • positively driven operation acc. to IEC 60947-5-1 | <p>Yes</p> <p>No</p> |
| Protection against electrical shock | finger-safe when touched vertically from front acc. to IEC 60529 |

Certificates/approvals

| General Product Approval | Functional Safety/Safety of Machinery | Declaration of Conformity |
|---|--|--|
|  CCC  CSA  UL  EAC | Type Examination Certificate |  EG-Konf. |

| Test Certificates | Marine / Shipping | other |
|--|--|------------------------------|
| Type Test Certificates/Test Report Special Test Certificate |  ABS  RMRS  DNV-GL <small>DNVGL.COM/AF</small> | Confirmation |

| other |
|-------------------------------|
| Miscellaneous |

Further information

- Information- and Downloadcenter (Catalogs, Brochures,...)**
<http://www.siemens.com/industrial-controls/catalogs>
- Industry Mall (Online ordering system)**
<https://mall.industry.siemens.com/mall/en/en/Catalog/product?mlfb=3RT1055-6AT36>
- Cax online generator**
<http://support.automation.siemens.com/WW/CAXorder/default.aspx?lang=en&mlfb=3RT1055-6AT36>
- Service&Support (Manuals, Certificates, Characteristics, FAQs,...)**
<https://support.industry.siemens.com/cs/ww/en/ps/3RT1055-6AT36>
- Image database (product images, 2D dimension drawings, 3D models, device circuit diagrams, EPLAN macros, ...)**
http://www.automation.siemens.com/bilddb/cax_de.aspx?mlfb=3RT1055-6AT36&lang=en
- Characteristic: Tripping characteristics, I²t, Let-through current**
<https://support.industry.siemens.com/cs/ww/en/ps/3RT1055-6AT36/char>
- Further characteristics (e.g. electrical endurance, switching frequency)**
<http://www.automation.siemens.com/bilddb/index.aspx?view=Search&mlfb=3RT1055-6AT36&objecttype=14&gridview=view1>

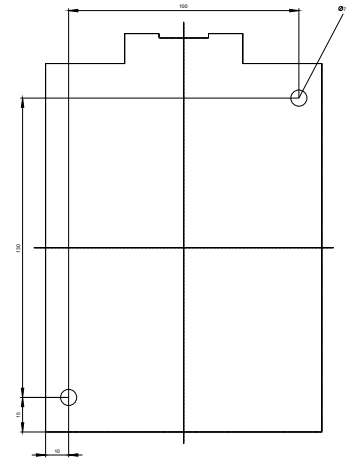
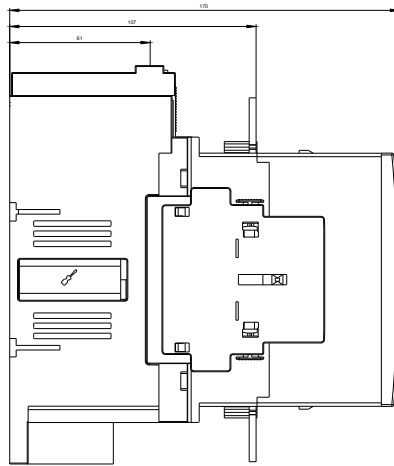
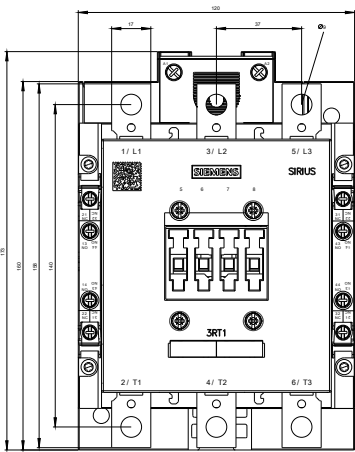



last modified:

12/19/2018