

Power contactor, AC-3 150 A, 75 kW / 400 V AC (50-60 Hz) / DC operation 200-277 V UC Auxiliary contacts 1 NO + 1 NC 3-pole, Size S6 Busbar connections Drive: electronic with PLC / SIMOCODE interface and RLT signal



Figure similar

Product brand name	SIRIUS
Product designation	Power contactor
Product type designation	3RT1
General technical data	
Size of contactor	S6
Product extension	
• function module for communication	No
• Auxiliary switch	Yes
Surge voltage resistance	
• of main circuit rated value	8 kV
• of auxiliary circuit rated value	6 kV
maximum permissible voltage for safe isolation	
• between coil and main contacts acc. to EN 60947-1	690 V
Protection class IP	
• on the front	IP00; IP20 on the front with cover / box terminal
• of the terminal	IP00

Shock resistance at rectangular impulse	
<ul style="list-style-type: none"> • at AC • at DC 	8,5g / 5 ms, 4,2g / 10 ms 8,5g / 5 ms, 4,2g / 10 ms
Shock resistance with sine pulse	
<ul style="list-style-type: none"> • at AC • at DC 	13,4g / 5 ms, 6,5g / 10 ms 13,4g / 5 ms, 6,5g / 10 ms
Mechanical service life (switching cycles)	
<ul style="list-style-type: none"> • of contactor typical • of the contactor with added electronics-compatible auxiliary switch block typical • of the contactor with added auxiliary switch block typical 	10 000 000 5 000 000 10 000 000
Reference code acc. to DIN 40719 extended according to IEC 204-2 acc. to IEC 750	K
Reference code acc. to DIN EN 81346-2	Q

Ambient conditions

Installation altitude at height above sea level	
<ul style="list-style-type: none"> • maximum 	2 000 m
Ambient temperature	
<ul style="list-style-type: none"> • during operation • during storage 	-25 ... +60 °C -55 ... +80 °C

Main circuit

Number of poles for main current circuit	3
Number of NO contacts for main contacts	3
Operating voltage	
<ul style="list-style-type: none"> • at AC-3 rated value maximum 	1 000 V
Operating current	
<ul style="list-style-type: none"> • at AC-1 at 400 V <ul style="list-style-type: none"> — at ambient temperature 40 °C rated value • at AC-1 <ul style="list-style-type: none"> — up to 690 V at ambient temperature 40 °C rated value — up to 690 V at ambient temperature 60 °C rated value — up to 1000 V at ambient temperature 40 °C rated value — up to 1000 V at ambient temperature 60 °C rated value • at AC-2 at 400 V rated value • at AC-3 <ul style="list-style-type: none"> — at 400 V rated value — at 500 V rated value 	185 A 185 A 160 A 90 A 90 A 150 A 150 A 150 A

<ul style="list-style-type: none"> — at 690 V rated value — at 1000 V rated value • at AC-4 at 400 V rated value 	150 A 65 A 132 A
Connectable conductor cross-section in main circuit at AC-1 <ul style="list-style-type: none"> • at 60 °C minimum permissible • at 40 °C minimum permissible 	70 mm ² 95 mm ²
Operating current for approx. 200000 operating cycles at AC-4 <ul style="list-style-type: none"> • at 400 V rated value • at 690 V rated value 	68 A 57 A
Operating current <ul style="list-style-type: none"> • at 1 current path at DC-1 <ul style="list-style-type: none"> — at 24 V rated value — at 110 V rated value — at 220 V rated value — at 440 V rated value — at 600 V rated value • with 2 current paths in series at DC-1 <ul style="list-style-type: none"> — at 24 V rated value — at 110 V rated value — at 220 V rated value — at 440 V rated value — at 600 V rated value • with 3 current paths in series at DC-1 <ul style="list-style-type: none"> — at 24 V rated value — at 110 V rated value — at 220 V rated value — at 440 V rated value — at 600 V rated value 	160 A 18 A 3.4 A 0.8 A 0.5 A 160 A 160 A 20 A 3.2 A 1.6 A 160 A 160 A 160 A 11.5 A 4 A
Operating current <ul style="list-style-type: none"> • at 1 current path at DC-3 at DC-5 <ul style="list-style-type: none"> — at 24 V rated value — at 110 V rated value — at 220 V rated value — at 440 V rated value — at 600 V rated value • with 2 current paths in series at DC-3 at DC-5 <ul style="list-style-type: none"> — at 24 V rated value — at 110 V rated value — at 220 V rated value — at 440 V rated value 	160 A 2.5 A 0.6 A 0.17 A 0.12 A 160 A 160 A 2.5 A 0.65 A

<ul style="list-style-type: none"> — at 600 V rated value 	0.37 A
<ul style="list-style-type: none"> • with 3 current paths in series at DC-3 at DC-5 <ul style="list-style-type: none"> — at 24 V rated value — at 110 V rated value — at 220 V rated value — at 440 V rated value — at 600 V rated value 	160 A 160 A 160 A 1.4 A 0.75 A
Operating power	
<ul style="list-style-type: none"> • at AC-1 <ul style="list-style-type: none"> — at 230 V at 60 °C rated value — at 400 V rated value — at 400 V at 60 °C rated value — at 690 V rated value — at 690 V at 60 °C rated value — at 1000 V at 60 °C rated value • at AC-2 at 400 V rated value • at AC-3 <ul style="list-style-type: none"> — at 230 V rated value — at 400 V rated value — at 500 V rated value — at 690 V rated value — at 1000 V rated value 	60 kW 105 kW 105 kW 181 kW 181 kW 148 kW 75 kW 45 kW 75 kW 90 kW 132 kW 90 kW
Operating power for approx. 200000 operating cycles at AC-4	
<ul style="list-style-type: none"> • at 400 V rated value • at 690 V rated value 	38 kW 55 kW
Thermal short-time current limited to 10 s	1 300 A
Power loss [W] at AC-3 at 400 V for rated value of the operating current per conductor	9 W
No-load switching frequency	
<ul style="list-style-type: none"> • at AC • at DC 	1 000 1/h 1 000 1/h
Operating frequency	
<ul style="list-style-type: none"> • at AC-1 maximum • at AC-2 maximum • at AC-3 maximum • at AC-4 maximum 	800 1/h 300 1/h 750 1/h 130 1/h
Control circuit/ Control	
Type of voltage of the control supply voltage	AC/DC
Control supply voltage at AC	
<ul style="list-style-type: none"> • at 50 Hz rated value 	200 ... 277 V

<ul style="list-style-type: none"> • at 60 Hz rated value 	200 ... 277 V
Control supply voltage at DC	
<ul style="list-style-type: none"> • rated value 	200 ... 277 V
Type of PLC-control input acc. to IEC 60947-1	Type 1
Consumed current at PLC-control input acc. to IEC 60947-1 maximum	20 mA
Operating range factor control supply voltage rated value of magnet coil at DC	
<ul style="list-style-type: none"> • initial value • Full-scale value 	0.8 1.1
Operating range factor control supply voltage rated value of magnet coil at AC	
<ul style="list-style-type: none"> • at 50 Hz • at 60 Hz 	0.8 ... 1.1 0.8 ... 1.1
Design of the surge suppressor	with varistor
Apparent pick-up power of magnet coil at AC	
<ul style="list-style-type: none"> • at 50 Hz 	280 V·A
Inductive power factor with closing power of the coil	
<ul style="list-style-type: none"> • at 50 Hz 	0.8
Apparent holding power of magnet coil at AC	
<ul style="list-style-type: none"> • at 50 Hz 	4.4 V·A
Inductive power factor with the holding power of the coil	
<ul style="list-style-type: none"> • at 50 Hz 	0.5
Closing power of magnet coil at DC	320 W
Holding power of magnet coil at DC	2.8 W
Closing delay	
<ul style="list-style-type: none"> • at AC • at DC 	35 ... 75 ms 35 ... 75 ms
Opening delay	
<ul style="list-style-type: none"> • at AC • at DC 	80 ... 90 ms 80 ... 90 ms
Arcing time	10 ... 15 ms
Control version of the switch operating mechanism	PLC-IN or Standard A1 - A2 (adjustable)
Auxiliary circuit	
Number of NC contacts for auxiliary contacts	
<ul style="list-style-type: none"> • instantaneous contact 	1
Number of NO contacts for auxiliary contacts	
<ul style="list-style-type: none"> • instantaneous contact 	1
Operating current at AC-12 maximum	10 A
Operating current at AC-15	
<ul style="list-style-type: none"> • at 230 V rated value • at 400 V rated value 	6 A 3 A

<ul style="list-style-type: none"> • at 500 V rated value • at 690 V rated value 	<p>2 A</p> <p>1 A</p>
Operating current at DC-12	
<ul style="list-style-type: none"> • at 24 V rated value • at 48 V rated value • at 60 V rated value • at 110 V rated value • at 125 V rated value • at 220 V rated value • at 600 V rated value 	<p>10 A</p> <p>6 A</p> <p>6 A</p> <p>3 A</p> <p>2 A</p> <p>1 A</p> <p>0.15 A</p>
Operating current at DC-13	
<ul style="list-style-type: none"> • at 24 V rated value • at 48 V rated value • at 60 V rated value • at 110 V rated value • at 125 V rated value • at 220 V rated value • at 600 V rated value 	<p>10 A</p> <p>2 A</p> <p>2 A</p> <p>1 A</p> <p>0.9 A</p> <p>0.3 A</p> <p>0.1 A</p>
Contact reliability of auxiliary contacts	1 faulty switching per 100 million (17 V, 1 mA)

UL/CSA ratings

Full-load current (FLA) for three-phase AC motor	
<ul style="list-style-type: none"> • at 480 V rated value • at 600 V rated value 	<p>156 A</p> <p>144 A</p>
Yielded mechanical performance [hp]	
<ul style="list-style-type: none"> • for single-phase AC motor <ul style="list-style-type: none"> — at 230 V rated value • for three-phase AC motor <ul style="list-style-type: none"> — at 200/208 V rated value — at 220/230 V rated value — at 460/480 V rated value — at 575/600 V rated value 	<p>30 hp</p> <p>50 hp</p> <p>60 hp</p> <p>125 hp</p> <p>150 hp</p>
Contact rating of auxiliary contacts according to UL	A600 / Q600

Short-circuit protection

Design of the fuse link	
<ul style="list-style-type: none"> • for short-circuit protection of the main circuit <ul style="list-style-type: none"> — with type of coordination 1 required — with type of assignment 2 required • for short-circuit protection of the auxiliary switch required 	<p>gG: 355 A (690 V, 100 kA)</p> <p>gG: 315 A (690 V, 100 kA), aM: 200 A (690 V, 50 kA), BS88: 315 A (415 V, 50 kA)</p> <p>gG: 10 A (500 V, 1 kA)</p>

Installation/ mounting/ dimensions

Mounting position	with vertical mounting surface +/-90° rotatable, with vertical mounting surface +/- 22.5° tiltable to the front and back
Mounting type	screw fixing
<ul style="list-style-type: none"> • Side-by-side mounting 	Yes
Height	172 mm
Width	140 mm
Depth	170 mm
Required spacing	
<ul style="list-style-type: none"> • with side-by-side mounting <ul style="list-style-type: none"> — forwards — upwards — downwards — at the side • for grounded parts <ul style="list-style-type: none"> — forwards — upwards — at the side — downwards • for live parts <ul style="list-style-type: none"> — forwards — upwards — downwards — at the side 	20 mm 10 mm 10 mm 0 mm 20 mm 10 mm 10 mm 10 mm 20 mm 10 mm 10 mm 10 mm

Connections/Terminals



Type of electrical connection	
<ul style="list-style-type: none"> • for main current circuit • for auxiliary and control current circuit 	Connection bar screw-type terminals
Type of connectable conductor cross-sections	
<ul style="list-style-type: none"> • at AWG conductors for main contacts 	4 ... 250 kcmil
Connectable conductor cross-section for main contacts	
<ul style="list-style-type: none"> • stranded 	25 ... 120 mm ²
Connectable conductor cross-section for auxiliary contacts	
<ul style="list-style-type: none"> • single or multi-stranded • finely stranded with core end processing 	0.5 ... 4 mm ² 0.5 ... 2.5 mm ²
Type of connectable conductor cross-sections	
<ul style="list-style-type: none"> • for auxiliary contacts <ul style="list-style-type: none"> — solid — single or multi-stranded — finely stranded with core end processing • at AWG conductors for auxiliary contacts 	2x (0.5 ... 1.5 mm ²), 2x (0.75 ... 2.5 mm ²), max. 2x (0.75 ... 4 mm ²) 2x (0,5 ... 1,5 mm ²), 2x (0,75 ... 2,5 mm ²), max. 2x (0,75 ... 4 mm ²) 2x (0.5 ... 1.5 mm ²), 2x (0.75 ... 2.5 mm ²) 2x (20 ... 16), 2x (18 ... 14), 1x 12

AWG number as coded connectable conductor cross section	
<ul style="list-style-type: none"> • for auxiliary contacts 	18 ... 14

Safety related data	
B10 value	
<ul style="list-style-type: none"> • with high demand rate acc. to SN 31920 	1 000 000
Product function	
<ul style="list-style-type: none"> • Mirror contact acc. to IEC 60947-4-1 • positively driven operation acc. to IEC 60947-5-1 	Yes No
Protection against electrical shock	finger-safe when touched vertically from front acc. to IEC 60529

Certificates/approvals

General Product Approval	Functional Safety/Safety of Machinery	Declaration of Conformity
 CCC  CSA  UL  EAC	Type Examination Certificate	 EG-Konf.

Test Certificates	Marine / Shipping	other
Special Test Certificate Type Test Certificates/Test Report	 ABS  RMRS  DNV-GL <small>TYPE APPROVED PRODUCT DNVGL.COM/AF</small>	Confirmation

other
Miscellaneous

Further information

- Information- and Downloadcenter (Catalogs, Brochures,...)**
<http://www.siemens.com/industrial-controls/catalogs>
- Industry Mall (Online ordering system)**
<https://mall.industry.siemens.com/mall/en/en/Catalog/product?mlfb=3RT1055-6PP35>
- Cax online generator**
<http://support.automation.siemens.com/WW/CAXorder/default.aspx?lang=en&mlfb=3RT1055-6PP35>
- Service&Support (Manuals, Certificates, Characteristics, FAQs,...)**
<https://support.industry.siemens.com/cs/ww/en/ps/3RT1055-6PP35>
- Image database (product images, 2D dimension drawings, 3D models, device circuit diagrams, EPLAN macros, ...)**
http://www.automation.siemens.com/bilddb/cax_de.aspx?mlfb=3RT1055-6PP35&lang=en

Characteristic: Tripping characteristics, I²t, Let-through current

<https://support.industry.siemens.com/cs/ww/en/ps/3RT1055-6PP35/char>

Further characteristics (e.g. electrical endurance, switching frequency)

<http://www.automation.siemens.com/bilddb/index.aspx?view=Search&mlfb=3RT1055-6PP35&objecttype=14&gridview=view1>

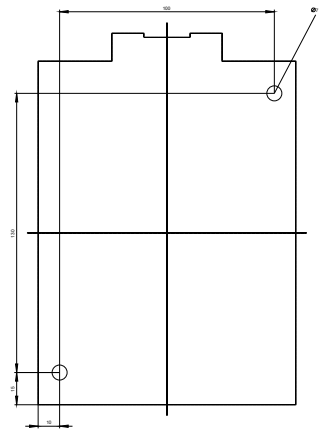
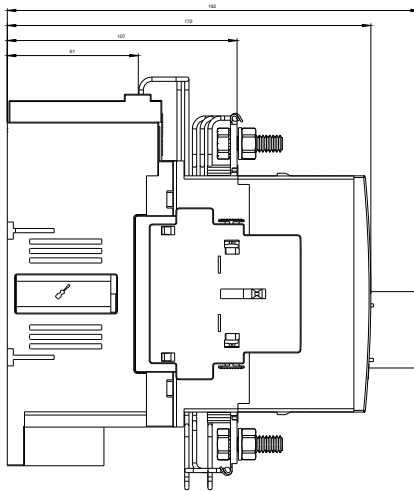
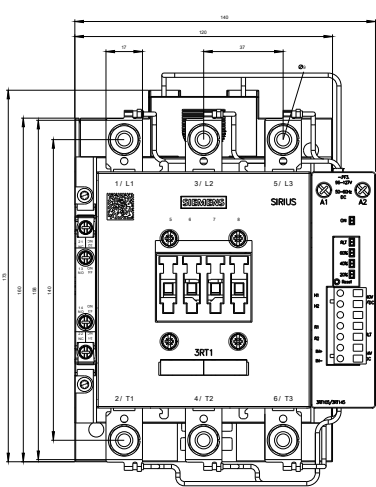

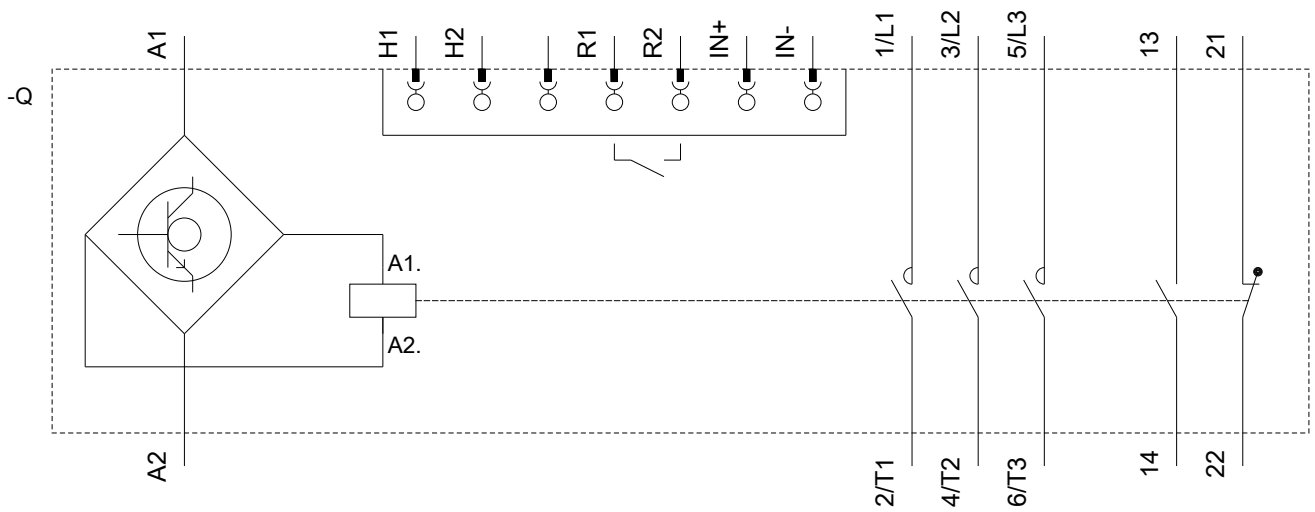

last modified:

12/22/2018